

ND056040932



Write your name here

Surname

Gedow

Other names

Mohamed

**Pearson Edexcel**  
**Level 1 / Level 2**  
**GCSE (9–1)**

Centre Number

1 0 6 5 8

Candidate Number

2 4 4 0

# Mathematics

## Paper 2 (Calculator)

### Higher Tier

Thursday 8 June 2017 – Morning

Time: 1 hour 30 minutes

Paper Reference

1MA1/2H

**You must have:** Ruler graduated in centimetres and millimetres, protractor, pair of compasses, pen, HB pencil, eraser, calculator. Tracing paper may be used.

Total Marks

29 29

### Instructions

- Use **black** ink or ball-point pen.
- **Fill in the boxes** at the top of this page with your name, centre number and candidate number.
- Answer **all** questions.
- Answer the questions in the spaces provided – *there may be more space than you need.*
- You must **show all your working**.
- Diagrams are **NOT** accurately drawn, unless otherwise indicated.
- **Calculators may be used.**
- If your calculator does not have a  $\pi$  button, take the value of  $\pi$  to be 3.142 unless the question instructs otherwise.



### Information

- The total mark for this paper is 80.
- The marks for **each** question are shown in brackets – *use this as a guide as to how much time to spend on each question.*

### Advice

- Read each question carefully before you start to answer it.
- Keep an eye on the time.
- Try to answer every question.
- Check your answers if you have time at the end.

Turn over ►

P48148RA

©2017 Pearson Education Ltd.  
 6/6/6/6/6/7/1/



P 4 8 1 4 8 R A 0 1 2 4



Pearson

Answer ALL questions.

Write your answers in the spaces provided.

You must write down all the stages in your working.

- 1 The table shows the probabilities that a biased dice will land on 2, on 3, on 4, on 5 and on 6  ✓  Q01

Number on dice	1	2	3	4	5	6
Probability	0.31	0.17	0.18	0.09	0.15	0.1

Neymar rolls the biased dice 200 times.

Work out an estimate for the total number of times the dice will land on 1 or on 3

$$0.17 + 0.18 + 0.09 + 0.15 + 0.1 = 0.69$$

$$1 - 0.69 = 0.31$$

$$0.31 + 0.18 = 0.49$$

$$0.49 \times 200 = 98$$

98

(Total for Question 1 is 3 marks)



- ② On Saturday, some adults and some children were in a theatre.  
The ratio of the number of adults to the number of children was 5 : 2

0



0

Q02

Each person had a seat in the Circle or had a seat in the Stalls.

$\frac{3}{4}$  of the children had seats in the Stalls.

117 children had seats in the Circle.

There are exactly 2600 seats in the theatre.

On this Saturday, were there people on more than 60% of the seats?

You must show how you get your answer.

$$5+2=7$$

117 children had seats in  
the circle.

~~$$\frac{3}{4} \times 2600 = 7800 = 1980$$~~

$$\frac{3}{4} \times 117 = 87.75 \approx 88$$

88 children had seats  
in the stalls

$$88 + 117 = 205$$

~~28~~ 
$$\frac{205}{3} = 68.3$$

no there wasn't  $68.3 \times 5 = 546$   
people on more than  
60% of the seats.

(Total for Question 2 is 5 marks)

2600  
00



P 4 8 1 4 8 R A 0 3 2 4

3

Turn over ▶

3 The diagram shows a prism with a cross section in the shape of a trapezium.

3



3

Q03

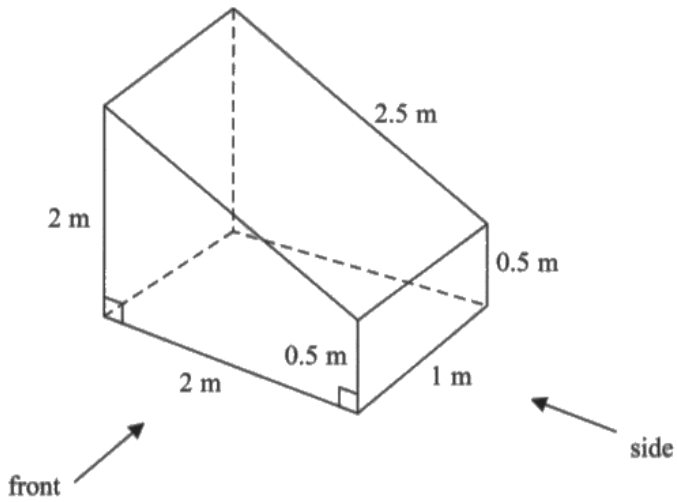

On the centimetre grid below, draw the front elevation and the side elevation of the prism.  
Use a scale of 2 cm to 1 m.

$\frac{1 \text{ m}}{2 \text{ m}}$

$2 \text{ cm} = \frac{1 \text{ m}}{2 \text{ m}}$

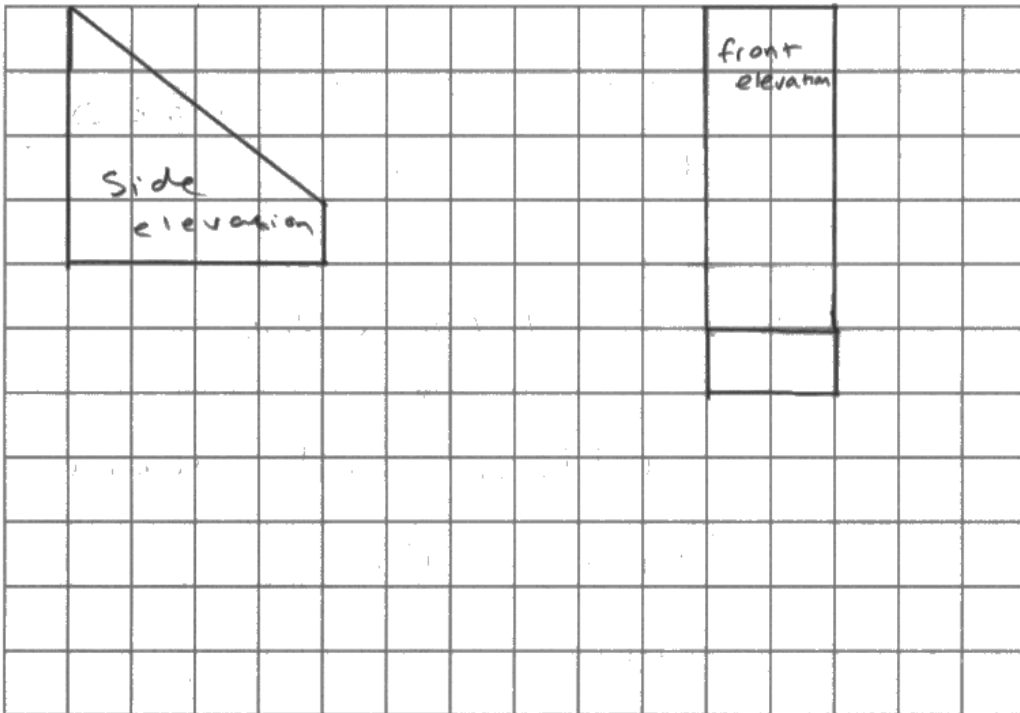

(Total for Question 3 is 4 marks)

3

3



4 Olly drove 56 km from Liverpool to Manchester. ✓  
 He then drove 61 km from Manchester to Sheffield. ✓

Olly's average speed from Liverpool to Manchester was 70 km/h.  
 Olly took 75 minutes to drive from Manchester to Sheffield.

Liverpool to Manchester  
 $D = 56 \text{ km}$   
 $S = 70 \text{ km/h}$   
 $t = 1.25 \text{ hours}$

(a) Work out Olly's average speed for his total drive from Liverpool to Sheffield. Liverpool

Liverpool to Manchester  
 $S = \frac{D}{t}$   
 $70 = \frac{56}{t}$   
 $\frac{70}{56} = t$   
 $t = 1.25 \text{ hours}$   
 $t = 75 \text{ mins} = 1 \text{ hour } 15 \text{ minutes.}$

Liverpool to Sheffield  
 $D = 56 + 61 = 117$   
 $t = 2.5$   
 $S = \frac{117}{2.5}$   
 $S = 46.8$

Manchester to Sheffield  
 $t = 1.25$   
 $D = 61$   
 $S = \frac{D}{t}$   
 $S = \frac{61}{1.25}$   
 $S = 48.8$

46.8 km/h  
 1 ✓

1 Q04a

Janie drove from Barnsley to York. ✓

Janie's average speed from Barnsley to Leeds was 80 km/h. ✓  
 Her average speed from Leeds to York was 60 km/h. ✓

Janie says that the average speed from Barnsley to York can be found by working out the mean of 80 km/h and 60 km/h. ✓

(b) If Janie is correct, what does this tell you about the two parts of Janie's journey?

Janie is not correct as she was driving at different speeds throughout the journey.

0 ✓

0 Q04b

(Total for Question 4 is 5 marks)  1  1



5

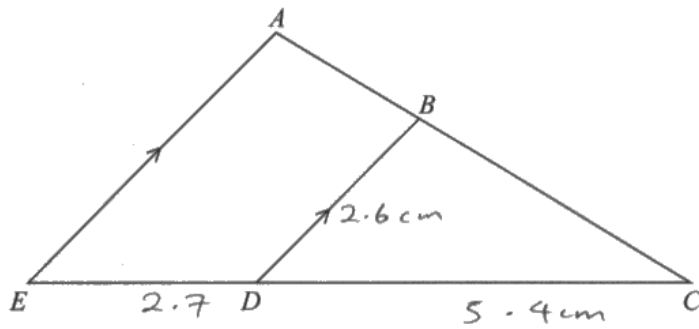

$ABC$  and  $EDC$  are straight lines.  
 $EA$  is parallel to  $DB$ .

8.1

$EC = 8.1$  cm.

$DC = 5.4$  cm.

$DB = 2.6$  cm.

(a) Work out the length of  $AE$ .

$$8.1 - 5.4 = 2.7$$

$$\frac{8.1}{5.4} = 1.5$$

$$2.6 \times 1.5 = 3.9$$

3.9

(2) 2 ✓

2 Q05a

$AC = 6.15$  cm.

(b) Work out the length of  $AB$ .

$$\frac{6.15}{1.5} = 4.1$$

$$BC = 6.15 - 4.1$$

$$BC =$$

$$BC = 4.1 \text{ cm}$$

$$AC = 6.15$$

2.05

(2) 2 ✓

2 Q05b

(Total for Question 5 is 4 marks) 4 4

6



6 Anil wants to invest £25 000 for 3 years in a bank.

3



3

Q06

**Personal Bank**

Compound Interest

2% for each year

**Secure Bank**

Compound Interest

4.3% for the first year  
0.9% for each extra year

Which bank will give Anil the most interest at the end of 3 years?

You must show all your working.

Personal Bank

$$1.02^3 \times £25,000 = £26530.2$$

Secure Bank

$$1.043 \times £25,000 = 26075$$

$$1.009^2 \times 26075 =$$

$$£26546.46$$

$$£26546.46 - £26530.2 = £16.26$$

Seco

Secure Bank will Anil the most  
interest after 3 years by £16.26.

(Total for Question 6 is 3 marks)

3

3

7 A number,  $n$ , is rounded to 2 decimal places.  
The result is 4.76

0



0

Q07

Using inequalities, write down the error interval for  $n$ .

$$4.76 + 0.05 = 4.81$$

$$4.76 - 0.05 = 4.71$$

$$4.71 \leq 4.76 \leq 4.81$$

~~4.71 < 4.76 < 4.81~~

(Total for Question 7 is 2 marks)

0

0



P 4 8 1 4 8 R A 0 7 2 4

7

Turn over ▶

8 The cumulative frequency graph shows some information about the heights, in cm, of 60 students.

0



0

Q08

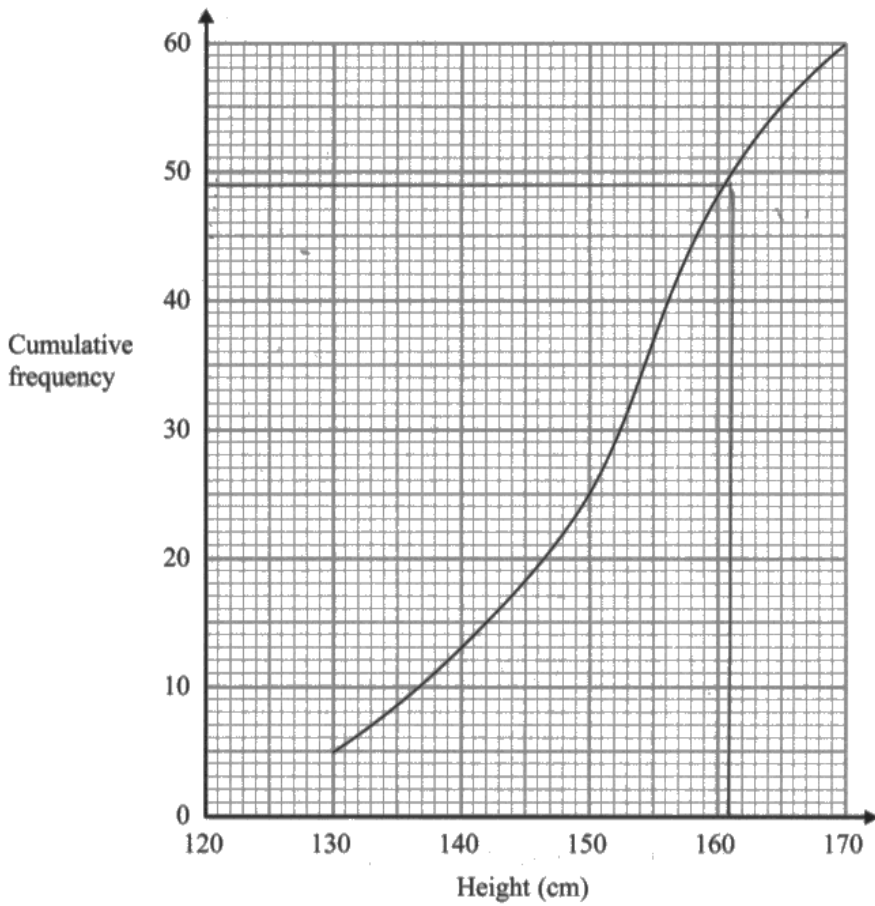

Work out an estimate for the number of these students with a height greater than 160 cm.

$$60 - 49 = 11$$

+1

(Total for Question 8 is 2 marks) 0 0





9 The diagram shows triangle A drawn on a grid.

0



0

Q09

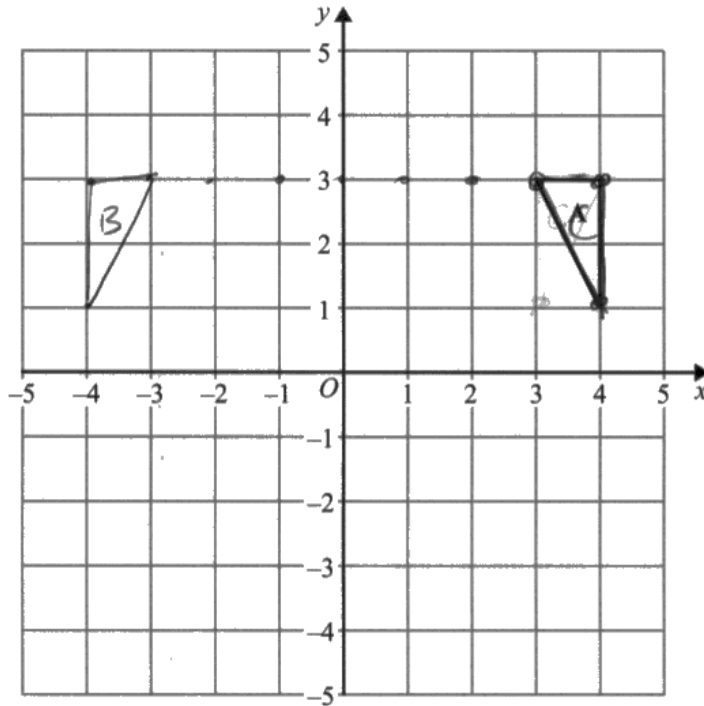

Kyle reflects triangle A in the  $x$ -axis to get triangle B.  
He then reflects triangle B in the line  $y = x$  to get triangle C.

Amy reflects triangle A in the line  $y = x$  to get triangle D.  
She is then going to reflect triangle D in the  $x$ -axis to get triangle E.

Amy says that triangle E should be in the same position as triangle C.

Is Amy correct?

You must show how you get your answer.

~~Amy is not correct~~  
~~no because triangle B was not~~  
~~reflected so it not be in~~  
~~the same exact position but~~  
~~it will be close to it~~  
~~as i~~  
Amy is correct as  
triangle B was reflected  
back into the same position

(Total for Question 9 is 3 marks)

0

0



P 4 8 1 4 8 R A 0 9 2 4

10 The table shows some information about eight planets.

Planet	Distance from Earth (km)	Mass (kg)
Earth	0	$5.97 \times 10^{24}$
Jupiter	$6.29 \times 10^8$	$1.898 \times 10^{27}$
Mars	$7.83 \times 10^7$	$6.42 \times 10^{23}$
Mercury	$9.17 \times 10^7$	$3.302 \times 10^{23}$
Neptune	$4.35 \times 10^9$	$1.024 \times 10^{26}$
Saturn	$1.28 \times 10^9$	$5.68 \times 10^{26}$
Uranus	$2.72 \times 10^9$	$8.683 \times 10^{25}$
Venus	$4.14 \times 10^7$	$4.869 \times 10^{24}$

(a) Write down the name of the planet with the greatest mass.

Uranus

(1) 0 ✓

0 Q10a

(b) Find the difference between the mass of Venus and the mass of Mercury.

$$4.869 \times 10^{24} - 3.302 \times 10^{23}$$

$$= 4.5388 \times 10^{24}$$

$$4.5388 \times 10^{24} \text{ kg}$$

(1) 1 ✓

1 Q10b

Nishat says that Neptune is over a hundred times further away from Earth than Venus is.

(c) Is Nishat right?

You must show how you get your answer. ~~Yes~~

Nishat  
Correct

is ~~wrong~~  
Neptune distance from earth

$$= 4.35 \times 10^9$$

Venus distance from earth

$$= 4.14 \times 10^7$$

$$\frac{4.35 \times 10^9}{4.14 \times 10^7} =$$

105 to 3.s.f.

~~$$\frac{4.35 \times 10^9}{4.14 \times 10^7} =$$~~

(2) 2 ✓

2 Q10c

3 3

(Total for Question 10 is 4 marks)



11 Solve  $\frac{3x-2}{4} - \frac{2x+5}{3} = \frac{1-x}{6}$

3



3

Q11

$$\frac{\overset{\times 3}{3x-2}}{\underset{\times 3}{4}}$$

$$\frac{\overset{\times 4}{2x+5}}{\underset{\times 4}{3}}$$

$$\frac{9x-6}{12} - \frac{8x+20}{12} = \frac{1-x}{6}$$

$$\frac{x+14}{12} = \frac{1-x}{6}$$

$$\frac{x+14}{12} = \frac{2-2x}{12}$$

x = .....

(Total for Question 11 is 4 marks)

3

3

$$\frac{3x}{12} = \frac{2-14}{12}$$

\*

$$\frac{3x}{12} = \frac{-12}{12}$$

$$\rightarrow 3x = \frac{-144}{12}$$

$$3x = -12$$

$$x = \frac{-12}{3}$$

$$x = -4$$



P 4 8 1 4 8 R A 0 1 1 2 4

12 There are 30 students in Mr Lear's class.  
16 of the students are boys.

Two students from the class are chosen at random.

Mr Lear draws this probability tree diagram for this information.

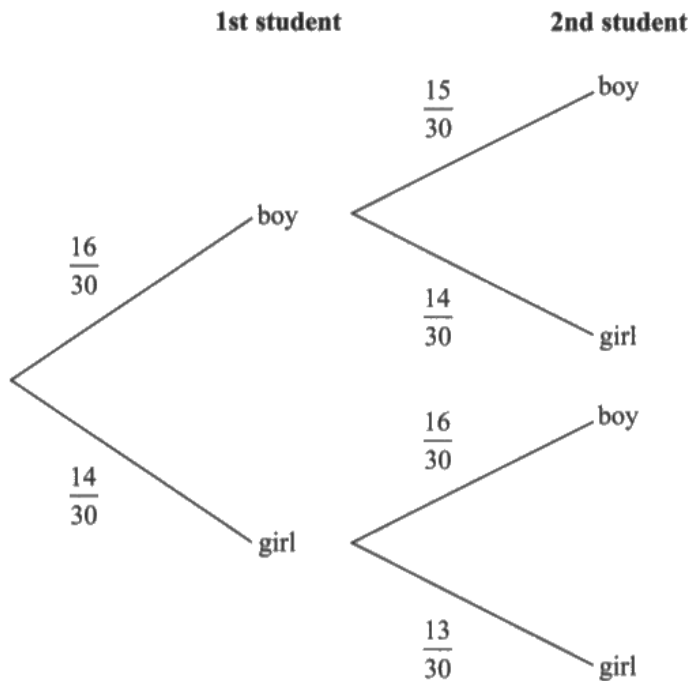

(a) Write down **one** thing that is wrong with the probabilities in the probability tree diagram.

(1)    Q12a

Owen and Wasim play for the school football team.

The probability that Owen will score a goal in the next match is 0.4  
The probability that Wasim will score a goal in the next match is 0.25

Mr Slater says,

“The probability that both boys will score a goal in the next match is  $0.4 + 0.25$ ”

(b) Is Mr Slater right?

Give a reason for your answer.

Mr Slater is ~~is~~ correct because  
~~that is why~~ you add the chances to  
get a higher chance.

(1)    Q12b

(Total for Question 12 is 2 marks)



13 The histogram shows some information about the ages of the 134 members of a sports club.

0



0

Q13

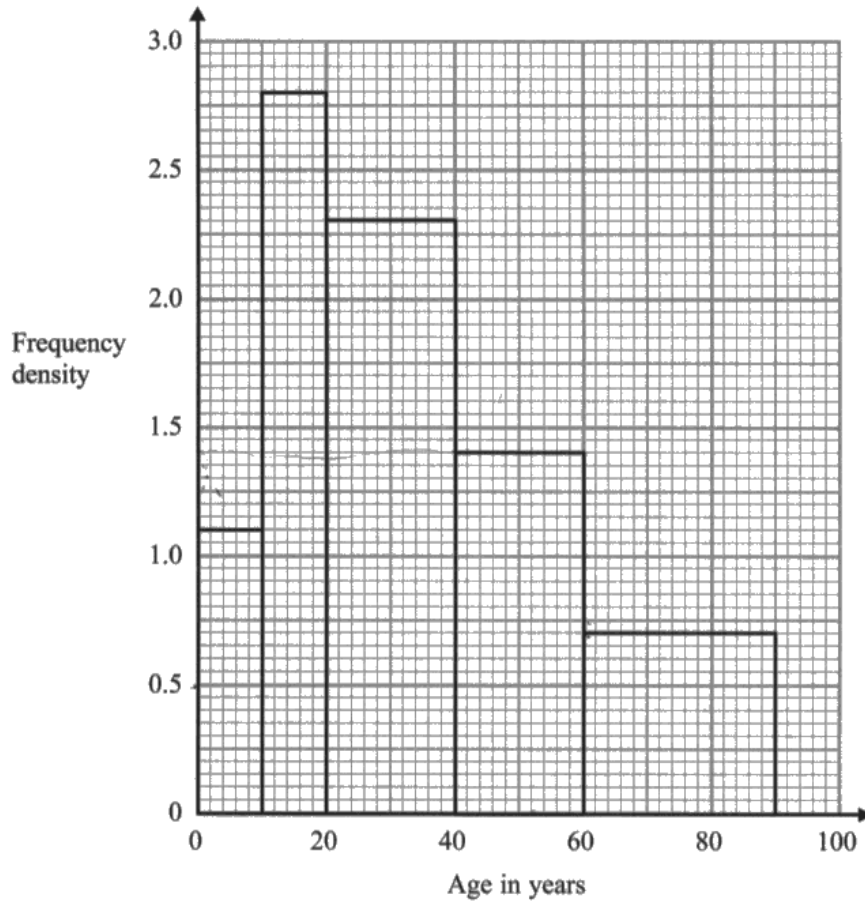

0.7

20% of the members of the sports club who are over 50 years of age are female.

Work out an estimate for the number of female members who are over 50 years of age.

$$\frac{1.4}{2} = 0.7$$

$$\begin{array}{r} 0.7 \\ \hline 0 \end{array}$$

$$0.7 + 0.7 = 1.4$$

$$1.4 \times 134$$

$$\begin{array}{r} 187.6 \\ - 188 \\ \hline 188 \end{array}$$

188

(Total for Question 13 is 3 marks)

0

0



14 Here are some graphs.

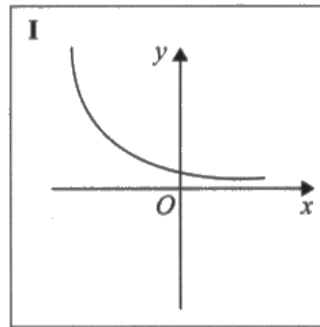
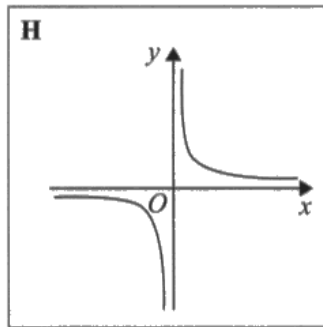
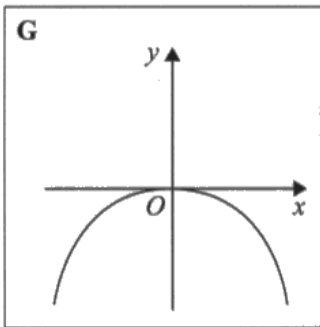
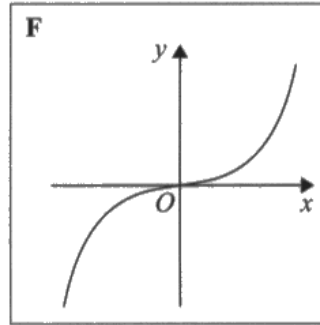
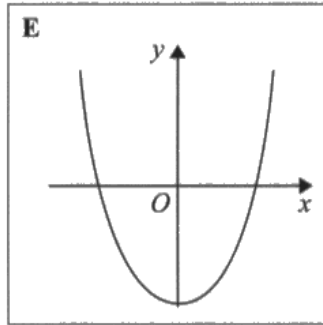
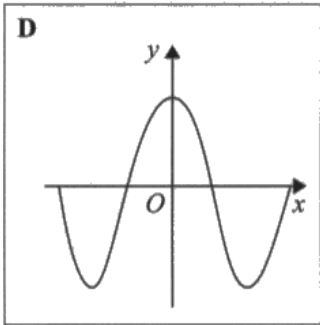
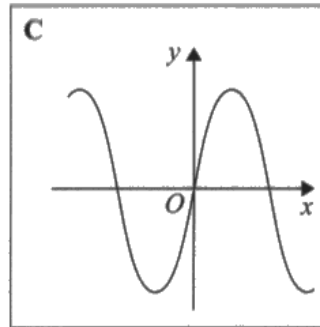
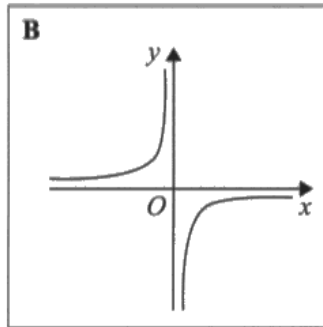
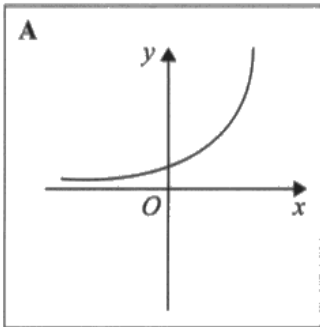

In the table below, match each equation with the letter of its graph.

3



3

Q14

Equation	Graph
$y = \sin x$	C
$y = x^3 + 4x$	<del>E</del> F
$y = 2^x$	A
$y = \frac{4}{x}$	H

(Total for Question 14 is 3 marks)

3

3



15  $A, B, C$  and  $D$  are four points on the circumference of a circle.

0



0

Q15

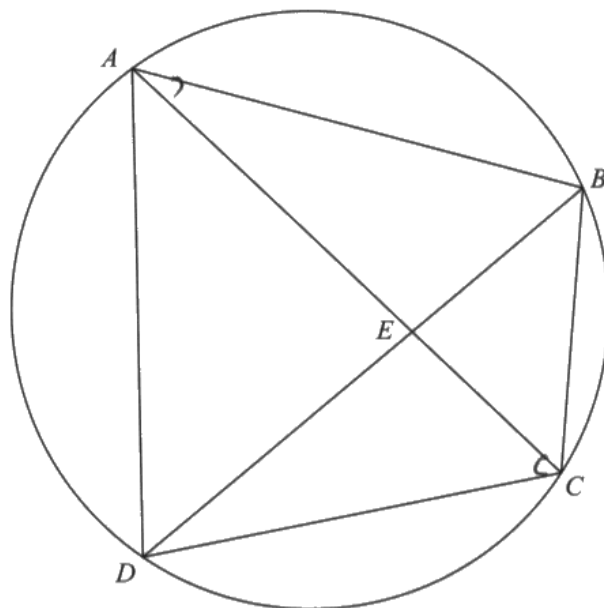

$AEC$  and  $BED$  are straight lines.

Prove that triangle  $ABE$  and triangle  $DCE$  are similar.  
You must give reasons for each stage of your working.

~~angle DEC =~~

$\angle DED = \angle AEB$  because vertically opposite angles are equal.

$\angle DCE = \angle BAE$  because angles that come from the same point from the circumference are equal.

Line  $DC$  is equal to line  $AB$  because the diameter of the circle is equal everywhere in the circle.

0

0

(Total for Question 15 is 3 marks)



P 4 8 1 4 8 R A 0 1 5 2 4

15

Turn over ▶

16 Using algebra, prove that  $0.\dot{1}\dot{3}\dot{6} \times 0.\dot{2}$  is equal in value to  $\frac{1}{33}$

3



3

Q16

$$\cancel{0.13636 \times 0.222 = \frac{1}{33}}$$

$$\frac{1}{33} = 0.\dot{0}3$$

$$0.13636 \times 0.222 = 0.0303$$

$$x = 0.\dot{0}303$$

$$\cancel{10x = 0.}$$

$$100x = 3.0303$$

$$\begin{aligned} 99x &= 3 \\ x &= \frac{3}{99} = \frac{1}{33} \end{aligned}$$

(Total for Question 16 is 3 marks)

3

3





17

0



0

Q17

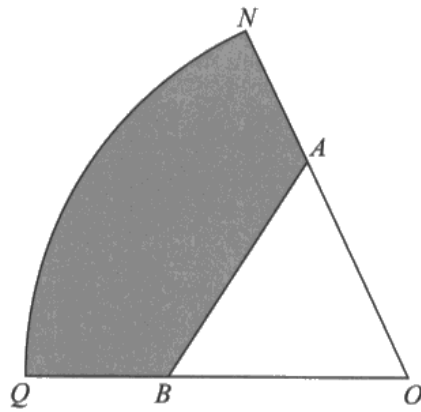

$ONQ$  is a sector of a circle with centre  $O$  and radius 11 cm.

$A$  is the point on  $ON$  and  $B$  is the point on  $OQ$  such that  $AOB$  is an equilateral triangle of side 7 cm.

Calculate the area of the shaded region as a percentage of the area of the sector  $ONQ$ .  
Give your answer correct to 1 decimal place.

.....%

0

0

(Total for Question 17 is 5 marks)



P 4 8 1 4 8 R A 0 1 7 2 4

17

Turn over ▶

18  $16^{\frac{1}{5}} \times 2^x = 8^{\frac{3}{4}}$

Work out the exact value of x.

~~$16^{\frac{1}{5}}$~~

✓

Q18

$16^{\frac{1}{5}} = 1.741101127$

$8^{\frac{3}{4}} = 4.75682846$

~~$16^{\frac{1}{5}}$~~

$4.75682846$

$1.741101127$

~~$16^{\frac{1}{5}} \times 2^x = 8^{\frac{3}{4}}$~~

$= 2.732080513$

$\frac{16^{\frac{1}{5}}}{8^{\frac{3}{4}}} = 2^x$

~~$8^{\frac{3}{4}}$~~

$2^x = 2.732080513$

~~$2^x =$~~

(Total for Question 18 is 3 marks)



9  $2 - \frac{x+2}{x-3} - \frac{x-6}{x+3}$  can be written as a single fraction in the form  $\frac{ax+b}{x^2-9}$

0



0

Q19

where  $a$  and  $b$  are integers.

Work out the value of  $a$  and the value of  $b$ .

$a = \dots\dots\dots 2$

$b = \dots\dots\dots 8$

(Total for Question 19 is 4 marks) 0 0



P 4 8 1 4 8 R A 0 1 9 2 4

20 The diagram shows part of the graph of  $y = x^2 - 2x + 3$

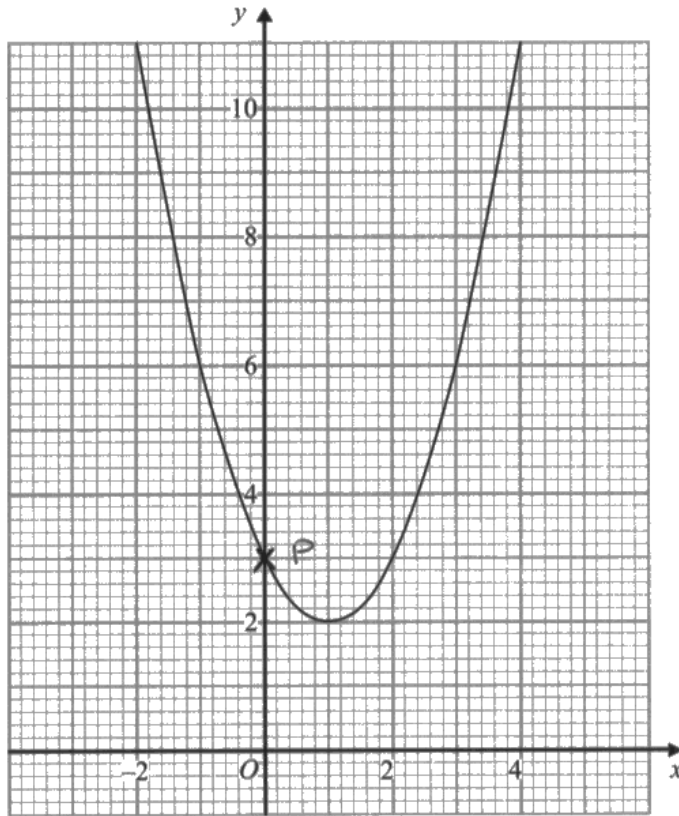

(a) By drawing a suitable straight line, use your graph to find estimates for the solutions of  $x^2 - 3x - 1 = 0$

(2)    Q20a

$P$  is the point on the graph of  $y = x^2 - 2x + 3$  where  $x = 2$

(b) Calculate an estimate for the gradient of the graph at the point  $P$ .

$$y = 2^2 - 2 \times 2 + 3$$

$$y = 3$$

(3)    Q20b

(Total for Question 20 is 5 marks)



21 The diagram shows 3 identical circles inside a rectangle. Each circle touches the other two circles and the sides of the rectangle, as shown in the diagram.

1

✓

1

Q21

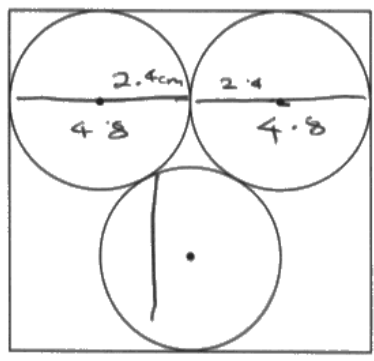

The radius of each circle is 24 mm.

Work out the area of the rectangle.  
Give your answer correct to 3 significant figures.

~~24 mm~~  
 $1 \text{ cm} = 10 \text{ mm}$   
 $\times 4.8$   $2.4 \text{ cm} = 24 \text{ mm}$   
 $\times 46.08$   $1 \text{ cm} = 10 \text{ mm}$   $\times 46.08$   
 $46.08 \text{ cm} =$

$2.4 \text{ cm} \times 2 = 4.8 \text{ cm}$       area of rectangle  
 $4.8 \times 2 = 9.6 \text{ cm}$        $= 460.8 \text{ mm}^2$   
width of rectangle = 9.6 cm       $A = \pi r^2$   
Length of rectangle = 4.8 cm       $A = \pi \times 24^2$   
 $9.6 \times 4.8 = 46.08 \text{ cm}^2$        $A = 1810 \times 3$   
 $A = 5430$

$\swarrow$  ~~1 cm = 100~~  
 $5430 + 460.8 =$   
 $5890.8$       ~~460.8~~ mm<sup>2</sup>  
(Total for Question 21 is 4 marks)

1

1



22 Here are the first five terms of a sequence.

1



1

Q22

4 7 11 15 22 37 56

Find an expression, in terms of  $n$ , for the  $n$ th term of this sequence.

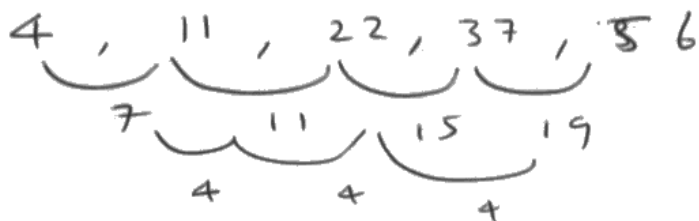

$$2 + b = 7$$

$$b = 5$$

$$2 + 5 + c = 7$$

$$c = 4 - 7$$

$$c = -3$$

$$an^2 + bn + c$$

~~$$2a =$$~~

$$2a = 2d$$

$$2a = 4$$

$$a = 2$$

$$2n^2 + 5n - 3$$

(Total for Question 22 is 3 marks)

1

1

$$a = 2^{\text{nd}} \text{ difference}$$

$$a + b = 1^{\text{st}} \text{ difference}$$

$$a + b + c = 1^{\text{st}} \text{ Term}$$



23 L is the circle with equation  $x^2 + y^2 = 4$

0



0

Q23

$P\left(\frac{3}{2}, \frac{\sqrt{7}}{2}\right)$  is a point on L.

Find an equation of the tangent to L at the point P.

(Total for Question 23 is 3 marks)

0

0

TOTAL FOR PAPER IS 80 MARKS

23



P 4 8 1 4 8 R A 0 2 3 2 4

**BLANK PAGE**

